



US005666041A

United States Patent [19]

Stuart et al.

[11] Patent Number: **5,666,041**

[45] Date of Patent: **Sep. 9, 1997**

[54] **BATTERY EQUALIZATION CIRCUIT WITH RAMP CONVERTER**

[75] Inventors: **Thomas A. Stuart, Maumee; Zhong Ye, Toledo, both of Ohio**

[73] Assignee: **The University of Toledo, Toledo, Ohio**

[21] Appl. No.: **703,445**

[22] Filed: **Aug. 27, 1996**

[51] Int. Cl.⁶ **H02J 7/00; H01M 10/44**

[52] U.S. Cl. **320/15; 320/17; 320/2; 320/6**

[58] Field of Search **320/17-18, 5-6, 320/2, 15-16, 39-40**

[56] **References Cited**

U.S. PATENT DOCUMENTS

3,305,754	2/1967	Oaks et al.	320/17 X
3,413,536	11/1968	Webb .	
3,793,544	2/1974	Baumgartner et al.	320/17
3,809,995	5/1974	Hardin 320/17 X	
3,930,192	12/1975	Dinkler .	
4,045,718	8/1977	Gray 320/17	
4,079,303	3/1978	Cox 320/17	
4,238,721	12/1980	DeLuca et al. .	
4,290,007	9/1981	Fisher et al. .	
4,331,911	5/1982	Park 320/17 X	
4,346,339	8/1982	Lewandowski .	
4,467,265	8/1984	Hierholzer 320/17	
4,616,170	10/1986	UrstÖger .	
4,656,411	4/1987	Carlson .	
4,748,342	5/1988	Dijkmans .	
4,876,495	10/1989	Palanisamy et al. .	
4,963,813	10/1990	Bolle 320/17	
4,967,136	10/1990	Nofzinger .	
5,003,244	3/1991	Davis, Jr 320/17	
5,063,340	11/1991	Kalenowsky .	
5,146,150	9/1992	Gyenes et al. .	
5,153,496	10/1992	LaForge .	
5,304,917	4/1994	Somerville .	
5,313,152	5/1994	Wozniak et al. .	

5,387,857	2/1995	Honda et al. .	
5,412,305	5/1995	Jeanneret	320/17
5,438,250	8/1995	Retzlaff .	
5,479,083	12/1995	Brainard	320/15 X

OTHER PUBLICATIONS

N. Kutkut, D. Divan, D. Novotny, "Charge Equalization for Series Connected Battery Strings," IEEE IAS Annual Meeting, Oct. 1994, pp. 1008-1015.

N. Kutkut, H. Weigman, D. Divan, D. Novotny, "Design Considerations for Charge Equalization of an Electric Vehicle Batter System", IEEE APEC, pp., 96-103, 1995.

B. Lindemark, "Individual Cell Voltage Equalizers (ICE) for Reliable Battery Performance", INTELEC Conf. Rec. pp. 196-201, Kyoto, Japan 1991.

Primary Examiner—Peter S. Wong

Assistant Examiner—K. Shin

Attorney, Agent, or Firm—Brinks Hofer Gilson & Lione

[57] **ABSTRACT**

An electronic battery equalization circuit that equalizes the voltages of a plurality of series connected batteries in a battery pack. The current waveform is in the shape of a ramp for providing zero current switching. The ramp converter power circuit has at least one semiconductor device and a transformer coupled to the equalizing voltage supply source. The transformer has a primary winding circuit and at least one secondary winding circuit. In one embodiment, each secondary winding circuit is connected to a different pair of batteries. The equalizing current is provided to the lowest voltage batteries in one half of the battery pack during one half of the charging cycle. The equalizing current is then provided to the lowest voltage batteries in the other half of the battery pack during the other half of the charging cycle. In another embodiment, each secondary winding circuit is connected to a different single battery. The equalizing current is supplied to a lowest voltage battery in the battery pack during each half of the switching cycle. The electronic battery equalization circuit also includes a feedback control circuit coupled to the primary winding circuit for controlling the current from the equalizing current supply source.

28 Claims, 8 Drawing Sheets

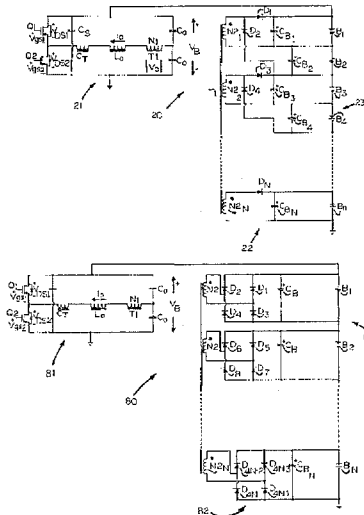

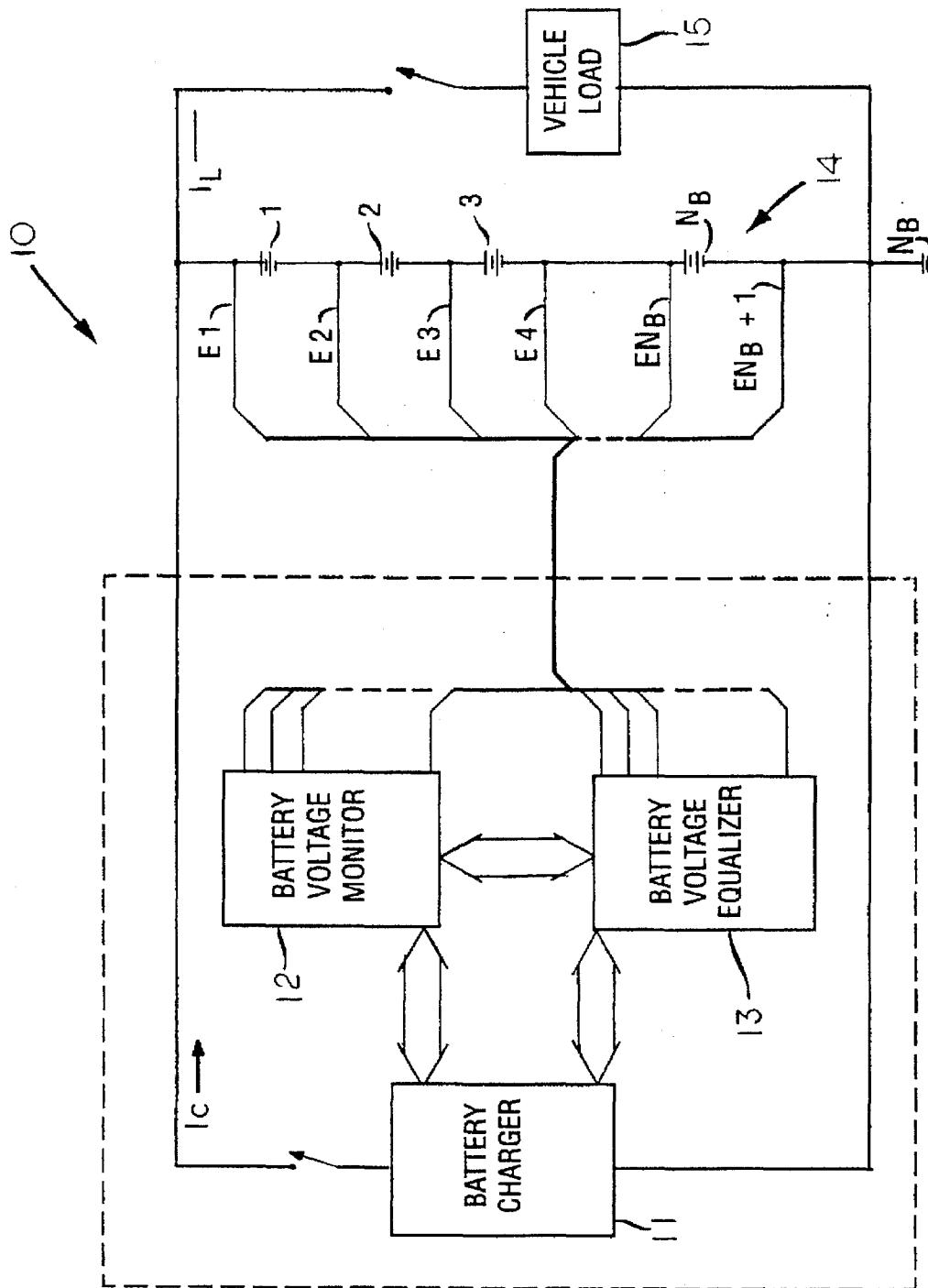

FIG. 1

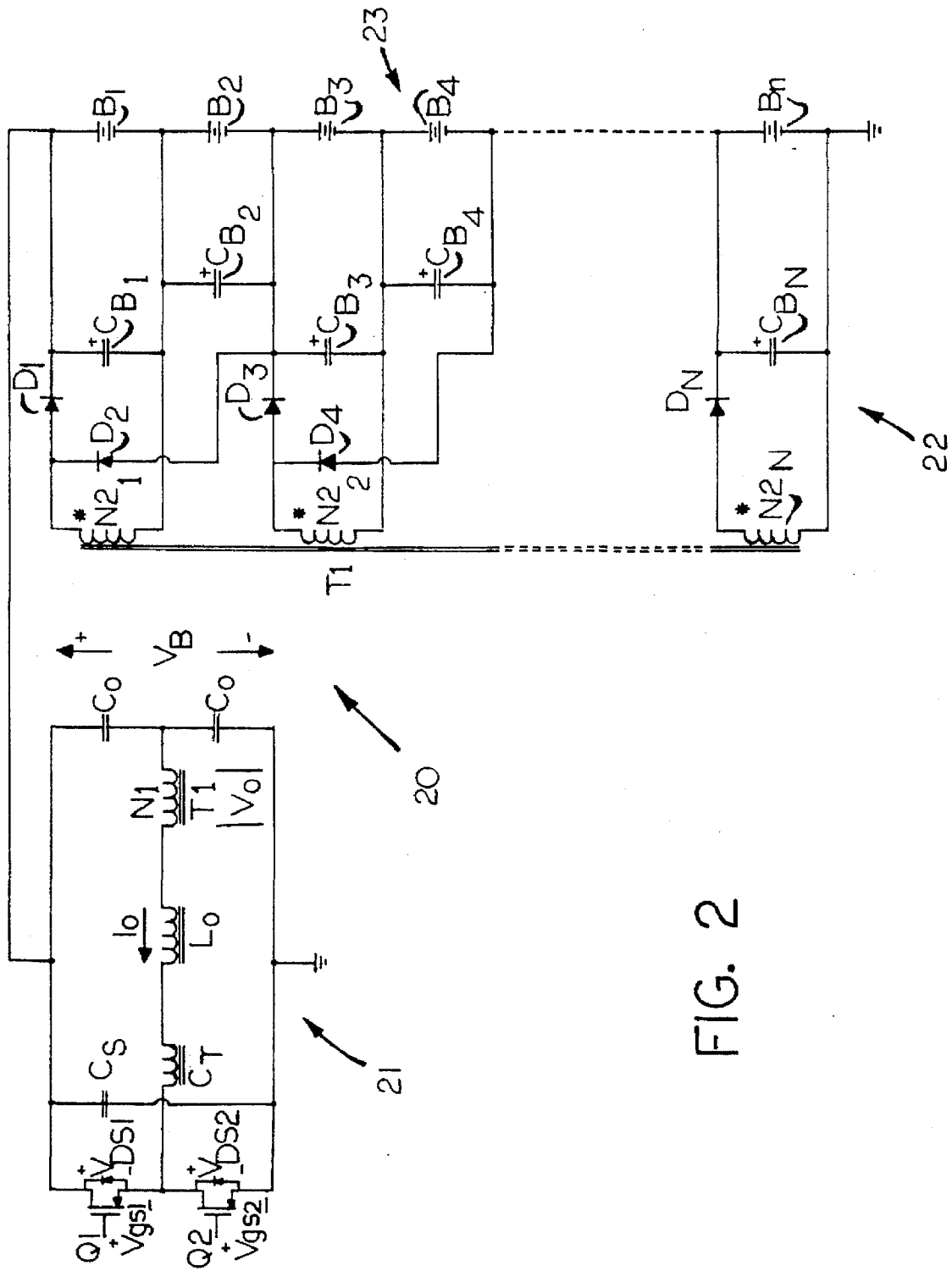

FIG. 2

FIG. 3

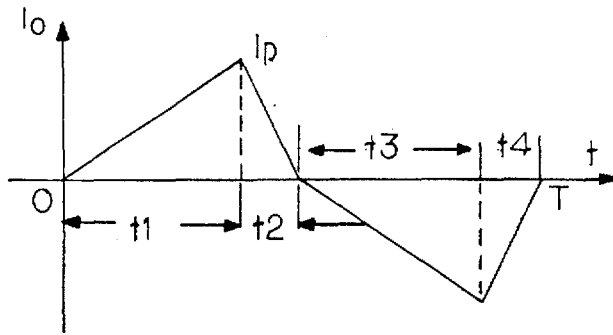

FIG. 6

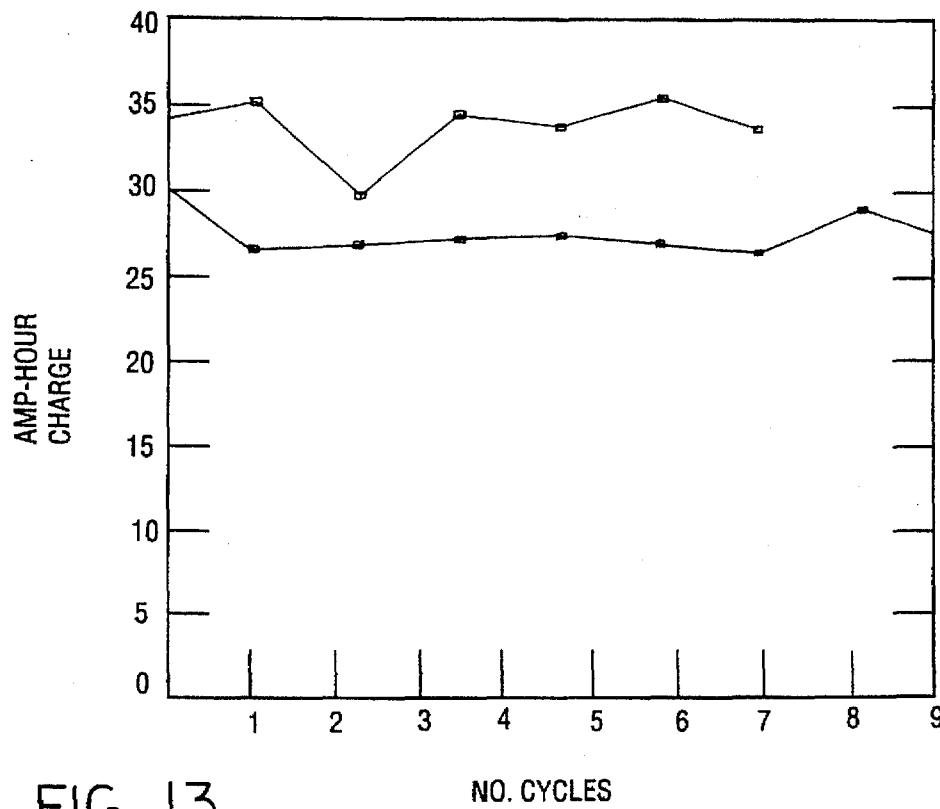
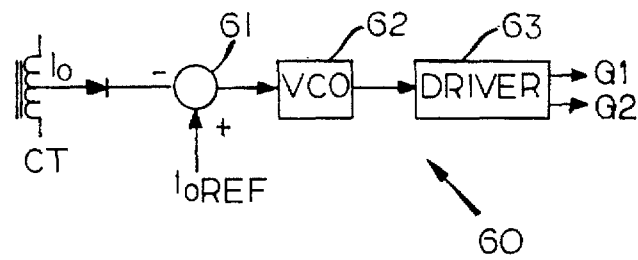

FIG. 13

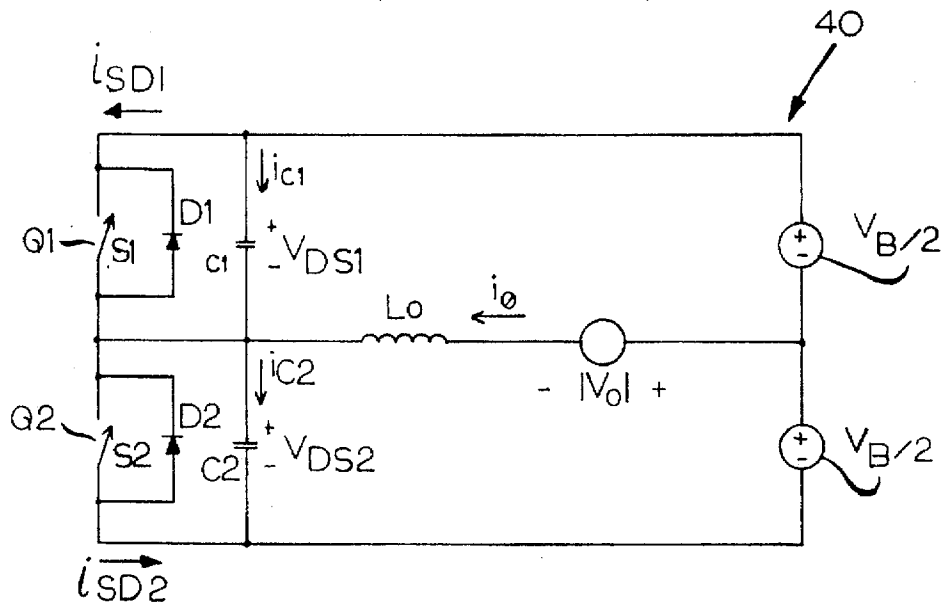

FIG. 4

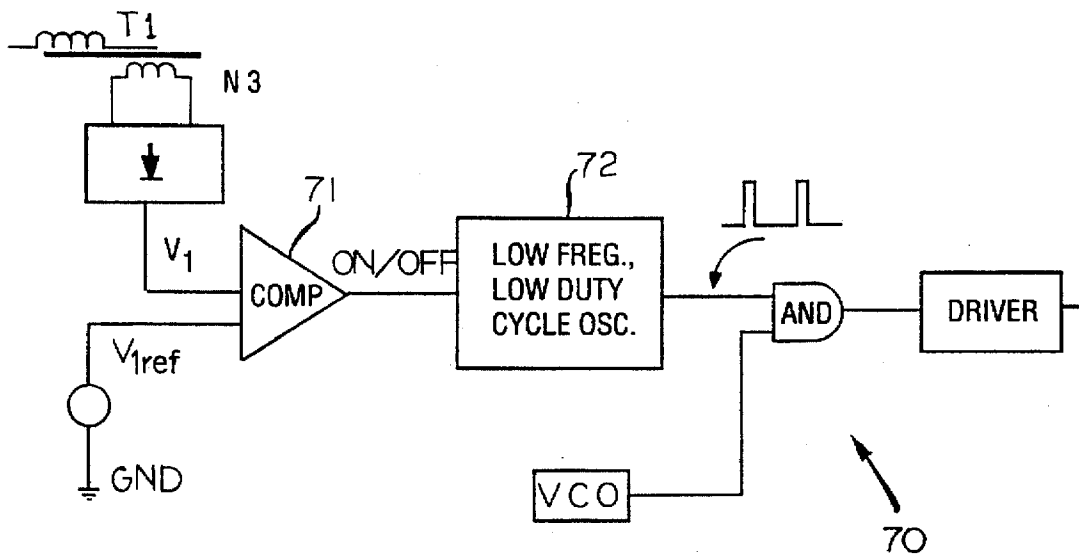

FIG. 7

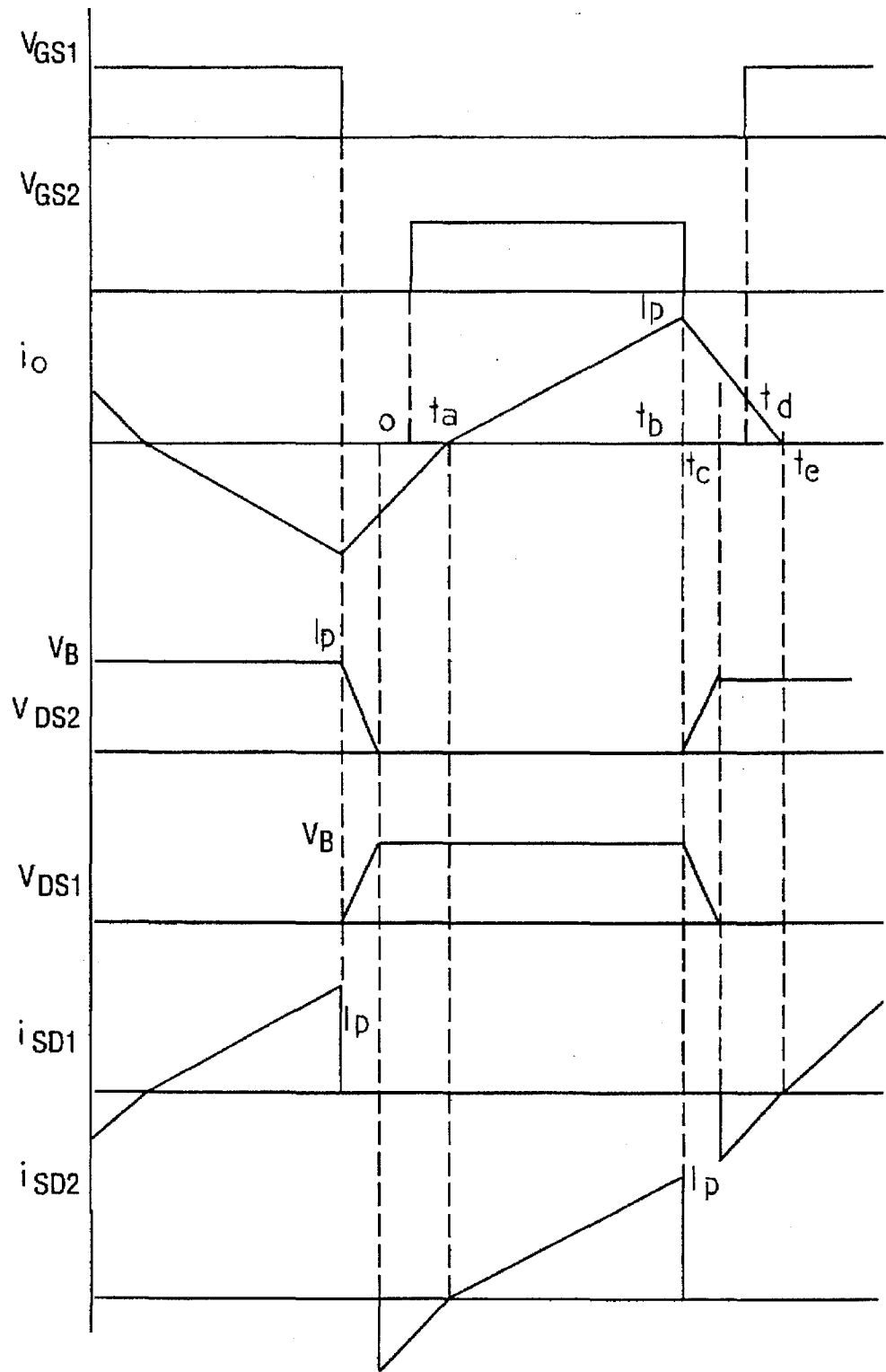

FIG. 5

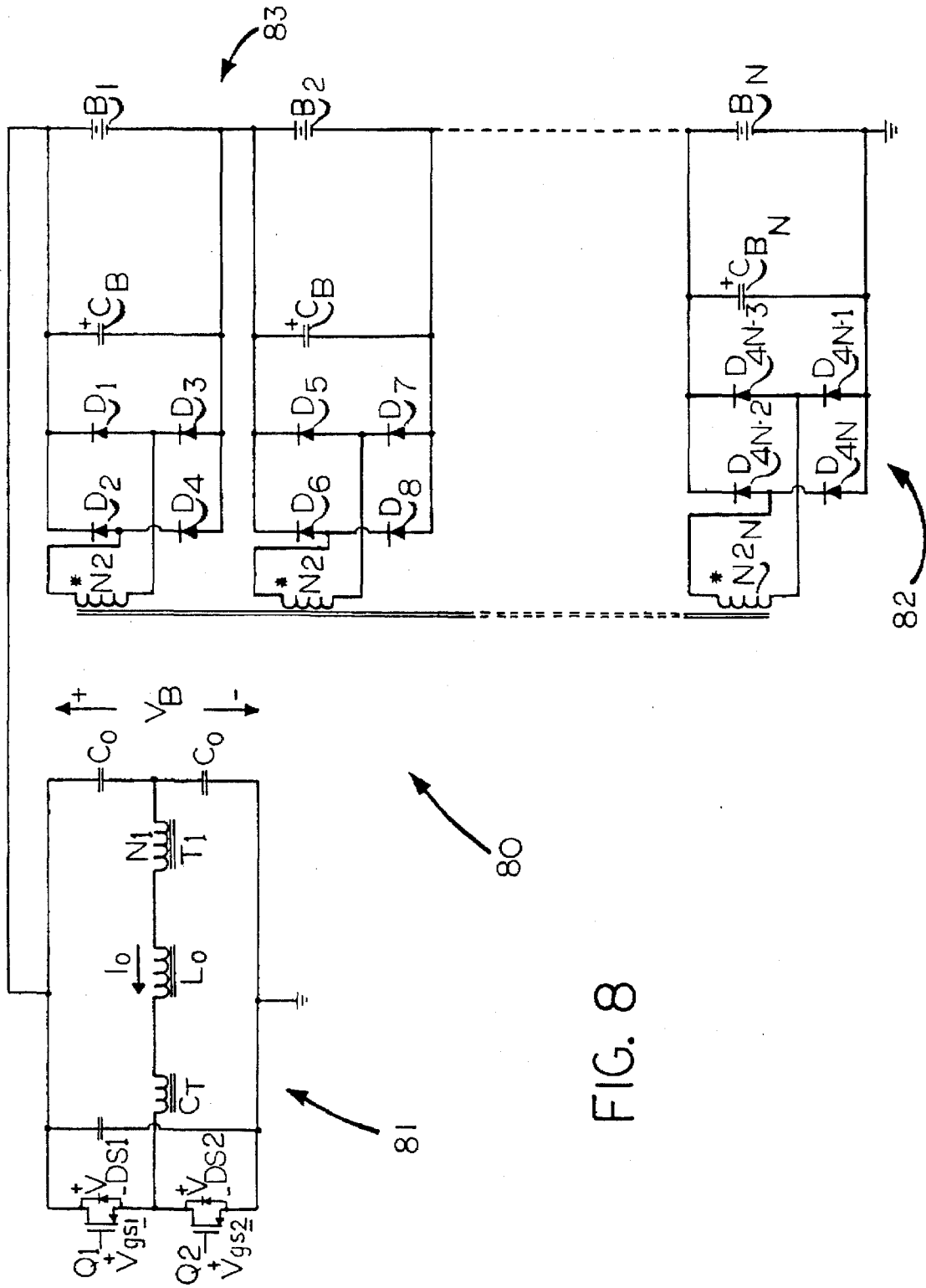

FIG. 8

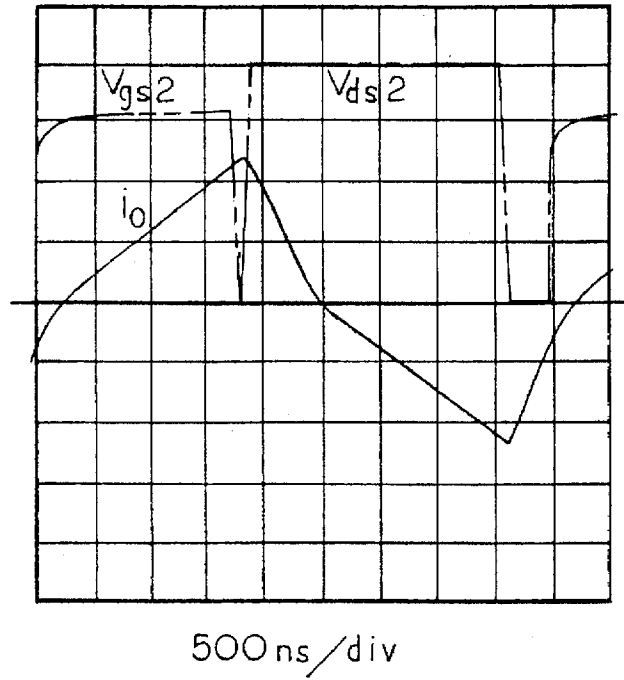

FIG. 9

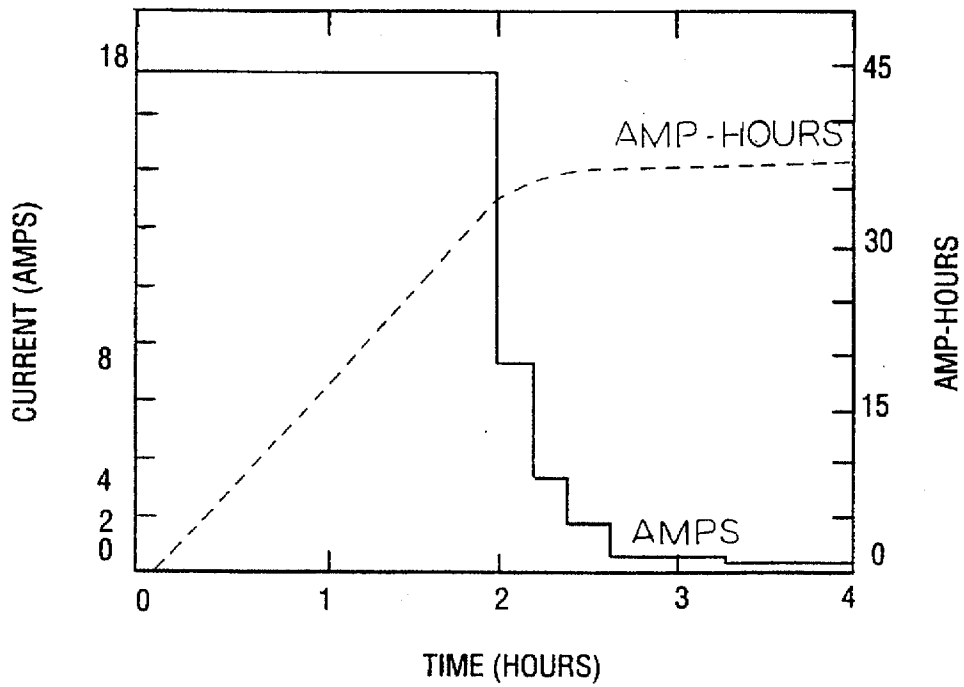

FIG. 10

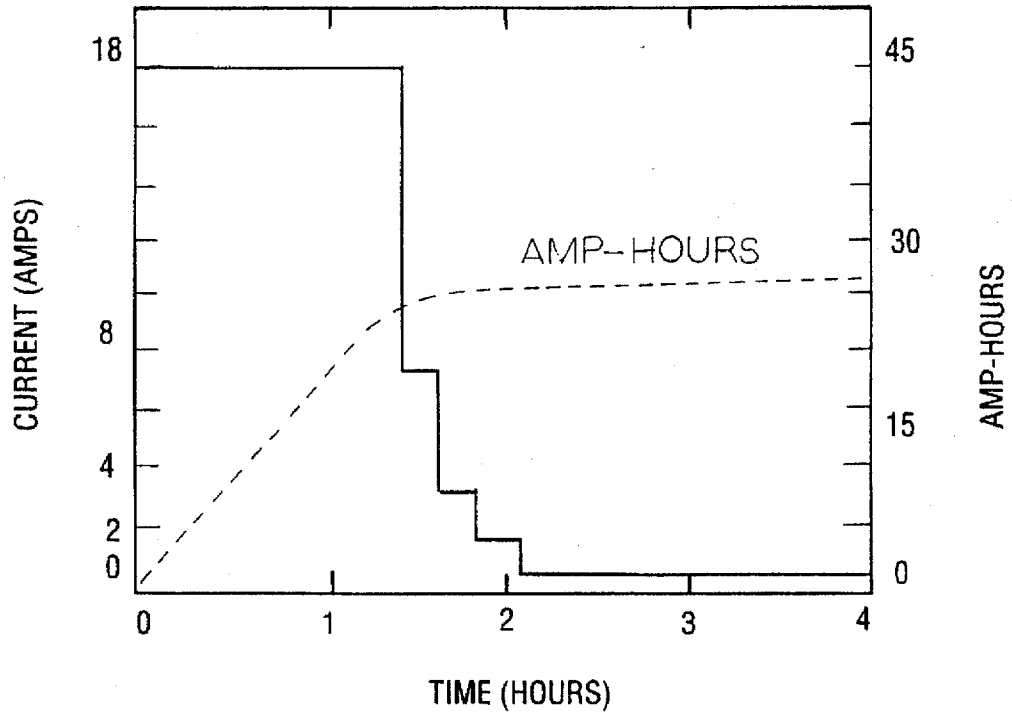

FIG. 11

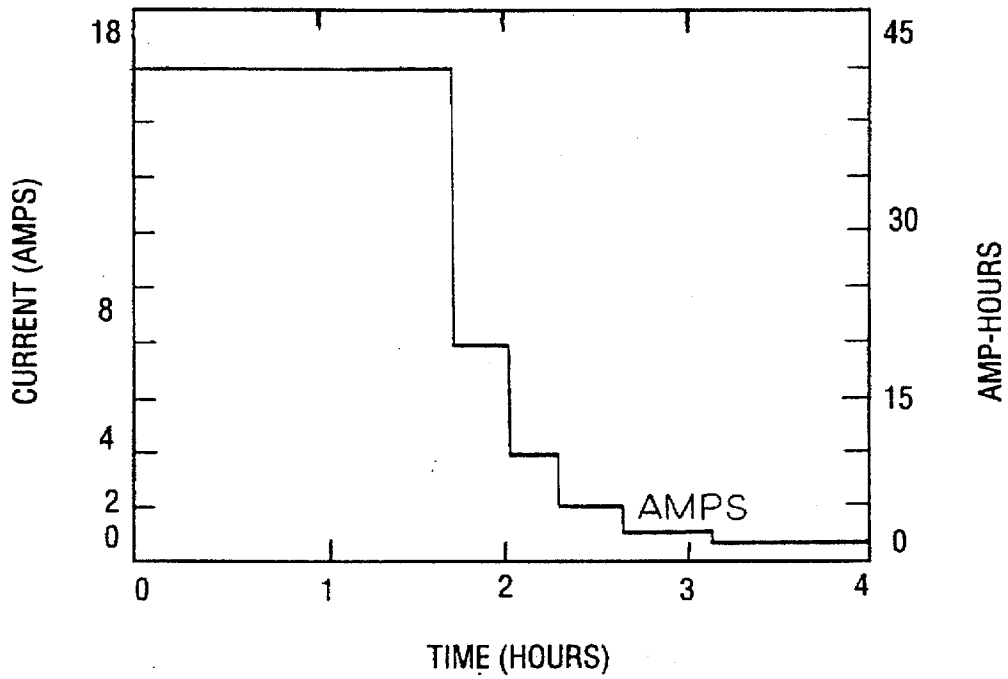

FIG. 12

BATTERY EQUALIZATION CIRCUIT WITH RAMP CONVERTER

BACKGROUND OF THE INVENTION

1. Field of the Invention

The invention relates in general to a battery voltage equalization circuit, and in particular, to a battery voltage equalization circuit using a ramp converter.

2. Related Art

It appears that battery packs consisting of several 12 V batteries connected in series to provide a 300-400 V.d.c power source, for example, will probably be the most popular battery pack for electric vehicles (EV's) and hybrid electric vehicles (HEV's).

Unfortunately, slight variations exist between individual batteries, and after several charge-discharge cycles, the battery voltages between the individual batteries begin to vary. If a battery voltage becomes too high during charging, the battery can no longer store all of the input charge, and "gassing" and overheating may occur. Gassing represents a loss of an electrolyte, and the overheating is detrimental to the electrodes. If a battery voltage becomes too low during discharge, the acidic concentration of the electrolyte may be diminished to a very low level. This can also damage the electrodes and shorten battery life.

To avoid these problems, a battery management system may be used to monitor the voltages of the individual batteries and take corrective action when any of these voltages reach their high or low limit. Corrective action consists of stopping the discharge at the lower limit and decreasing or stopping the charge at the higher limit. However, this also means a single low voltage battery can force a premature shutdown and greatly diminish the range of the vehicle. Likewise, a single high voltage can force a reduction in charging current and greatly increase the required charging time. Therefore, it is important to incorporate some equalization process for keeping all of the battery voltages close to the same value.

There are a wide variety of equalization strategies and an even wider variety of implementations, some of which will be described below. The high current portion of the charge period is called the "bulk charge" since this is where the battery receives most of its energy. The remaining low current portion (perhaps 1 Ampere, or so) is called the "trickle charge."

The most common equalization method is to simply allow the batteries to trickle charge for a few hours after the bulk charge is complete. This low current increases the charge in the undercharged, low voltage batteries without causing excessive heating or gassing in the fully charged, high voltage batteries. This equalizing method is effective, but it requires an excessive charge time.

Electro-mechanical equalizers can be used to monitor all of the battery voltages and selectively connect the output of a transformer coupled DC-DC Converter to provide additional charge to the lowest voltage battery(s). These equalizers are so named because a set of electro-mechanical relays seems to be the most practical means of connecting the converter to the individual batteries. These units also are effective, but they are relatively complex and expensive.

Most electronic equalizers consist of a transformer coupled DC-DC converter with several secondary windings and rectifiers. Usually there is a separate secondary winding and rectifier for each battery, but other combinations are possible. The converter is operated in the constant current

mode, and the circuit is arranged so that each battery is effectively connected in parallel with the converter output. This means the lower voltage batteries will "hog" the output current and thus receive an extra charge to increase their voltages. These equalizers are much simpler and cheaper than the electro-mechanical types, and tests indicate they can provide very effective equalization.

Although electronic equalizers offer certain advantages over the electro-mechanical variety, several of the previous units have fairly high switching losses, and the large number of secondary windings complicates the transformer construction.

SUMMARY OF THE INVENTION

To solve the foregoing problems, it is an object of the invention to provide a cost-effective electronic battery equalization circuit that has low losses and a decreased number of secondary windings.

To achieve these and other objectives, the invention is directed to an electronic battery equalization circuit for equalizing voltages of batteries in a battery pack. In the first preferred embodiment, the equalization circuit includes a current source for supplying a charging current during a first half cycle and a second half cycle, a transformer connected to the current source, a primary circuit connected to the transformer and at least one secondary circuit connected to said transformer. The primary circuit includes a primary winding, an inductor connected in series to the primary winding, a current transformer connected in series to the inductor and a pair of semiconductor devices, preferably field-effect transistors. The secondary circuit includes a secondary winding coupled to a different pair of batteries, a pair of diodes connected in series, each diode is connected to a different battery, and a capacitor connected across a different battery. The charging current from the current source is supplied to at least one battery in a first half of the battery pack during the first half cycle, and the charging current from the current source is supplied to at least one battery in a second half of the battery pack during the second half cycle.

The primary circuit also includes a negative feedback control circuit coupled to the current transformer. The negative feedback control circuit includes an error amplifier coupled to the current transformer, a voltage controlled oscillator coupled to the error amplifier and a driver coupled to the voltage controlled oscillator for outputting a drive signal to the pair of semiconductor devices. The error amplifier compares the charging current to a reference charging current and outputs a signal to the voltage controlled oscillator. The signal represents a difference between the charging current and the reference charging current.

A short circuit protection system is coupled to the feedback control circuit. The short circuit protection system includes a comparator connected to the transformer for comparing a voltage from the transformer to a reference voltage. The short circuit protections system also includes an oscillator connected to the comparator for supplying an output signal being combined with the drive signal from the voltage controlled oscillator.

In a second preferred embodiment, the equalization circuit includes a current source for supplying a charging current during a first half cycle and a second half cycle, a transformer connected to the current source, a primary circuit connected to the transformer and at least one secondary circuit connected to the transformer. The primary circuit includes a primary winding, an inductor connected in

series to the primary winding, a current transformer connected in series to the inductor and a pair of semiconductor devices. The secondary circuit includes a secondary winding coupled to a battery using a full wave rectifier and a capacitor connected across a battery. The charging current is supplied to the lowest voltage batteries in the battery pack during the first half cycle of the current source and the charging current is supplied to lowest voltage batteries in the battery pack during the second half cycle of the current source.

These and other aspects and advantages of the invention are described or apparent from the following detailed description of the preferred embodiments and appended drawings wherein like reference numbers refer to the same element, feature or component.

BRIEF DESCRIPTION OF THE DRAWINGS

The preferred embodiments are described with reference to the drawings in which:

FIG. 1 shows a block diagram of a battery management system using an electronic battery equalization circuit;

FIG. 2 shows a diagram of the electronic battery equalization circuit according to a first preferred embodiment of the invention;

FIG. 3 shows a graph of the primary current waveform;

FIG. 4 shows a diagram of an equivalent circuit of the electronic battery equalization circuit of FIG. 2;

FIG. 5 shows a graph of idealized waveforms of the equivalent circuit of FIG. 4;

FIG. 6 shows a block diagram of a feedback control system;

FIG. 7 shows a block diagram of a short circuit protection system;

FIG. 8 shows a diagram of the electronic battery equalization circuit according to a second preferred embodiment of the invention;

FIG. 9 shows a graph of waveforms for a 60-watt electronic battery equalization circuit using the invention;

FIG. 10 shows a charging profile with no equalization, 11.5 volts previous discharge and no defective batteries using the invention;

FIG. 11 shows a charging profile with no equalization, 11.5 volts previous discharge and one defective batteries using the invention;

FIG. 12 shows a charging profile with a ramp equalizer, 11.5 volts previous discharge and no defective batteries using the invention; and

FIG. 13 shows a graph of Amp-hour charge as a function of number of cycles with one defective battery and a maximum charge current of 18 amps using the invention.

DETAILED DESCRIPTION OF THE PREFERRED EMBODIMENTS

FIG. 1 shows a block diagram of a battery management system 10. The battery management system 10 comprises a battery charger 11, a battery voltage monitor 12 and a battery voltage equalizer 13. Battery charger 11 supplies a charging current or equalizing current, I_c , to a battery pack 14 of N_B batteries supplying electrical power to a load 15. Battery voltage monitor 12 monitors the voltages, E_1, \dots, E_{N_B} , of the individual N_B batteries and takes corrective action when any of these voltages reach their high or low predetermined limit. Corrective action consists of stopping the discharge at the lower limit and decreasing or stopping the charge at the higher limit.

As described below, during all phases of operation, battery voltage equalizer 13 equalizes the voltages of battery pack 14 using an electronic battery equalization circuit according to preferred embodiments of the invention. Thus, the voltages of battery pack 14 can be equalized by the battery voltage equalizer 13 while the batteries of battery pack 14 are charging, discharging or at rest. It should also be appreciated that the invention is not limited by the equalizing current being supplied by battery charger 11 and that the invention can also be practiced by supplying electrical current from any external source or even from battery pack 14.

FIG. 2 shows a diagram of the electronic battery equalization circuit 20 according to a first preferred embodiment of the invention. In general, the electronic battery equalization circuit 20 includes a number of batteries, B_1, \dots, B_n , connected in series and a primary circuit 21 with a transformer, T1, and at least one secondary winding, N_{21}, \dots, N_{2N} , connected to a secondary circuit 22. Primary circuit 21 includes a half-bridge circuit including a primary winding, N_1 , an inductor, L_o connected in series to primary winding, N_1 , a current transformer, C_T , connected in series to inductor, L_o , and a pair of semiconductor devices, Q1, preferably field-effect transistors (FET's). Primary winding circuit 21 also includes a pair of capacitors, C_o , to provide a path for current, i_o , and a capacitor, C_s , to minimize the effect of stray inductance. Secondary circuit 22 includes a number of secondary windings, N_{21}, \dots, N_{2N} , a number of output diodes, D_1, \dots, D_n , and a number of capacitors, C_1, \dots, C_{B_N} . Each diode, D_1, \dots, D_n , is connected in series to a different battery, B_1, \dots, B_n . Each capacitor, C_1, \dots, C_{B_N} , is coupled across a different battery, B_1, \dots, B_n .

An important transformer simplification feature of the invention is the number of secondary windings N_{21}, \dots, N_{2N} required for the electronic equalization circuit 20 of the first preferred embodiment. The arrangement requires only one secondary winding for each pair of batteries. In other words, secondary winding, N_{21} , for example, is required for batteries B_1 and B_2 . If the total number of batteries, B_N , is equal to an odd number, for example, twenty-seven, one of the secondary windings, for example, N_{2N} , is connected to battery B_n as shown in FIG. 2. However, if the total number of batteries, B_N , is equal to an even number, equalization circuit 20 would be the same as shown in FIG. 2, except secondary winding, N_{2N} , would be connected to the last two batteries, B_{N-1} and B_N , in the same way that the top secondary winding, N_{21} , connects to the first two batteries, B_1 and B_2 . The electronic battery equalization circuit 20 is only operated in the constant current mode and batteries B_1, \dots, B_n limit the maximum output voltage of equalization circuit 20. Capacitors C_B are required to minimize the effect of the stray inductance of the leads connected to batteries B_1, \dots, B_n and to reduce the electromagnetic interference (EMI) caused by the currents in these leads.

As illustrated in FIG. 2, the arrangement between secondary windings N_{21}, \dots, N_{2N} , rectifiers or output diodes D_1, \dots, D_n and batteries B_1, \dots, B_n is such that the instantaneous current, i_o , is supplied to the lowest voltage batteries of one half of the battery pack 23, and in particular, to the odd numbered battery(s) (B_1, B_3, \dots), on the semiconductor device Q1 half cycle. Likewise, current, i_o , is supplied to a lowest voltage battery of the other half of the battery pack 23, and in particular, to the even numbered battery(s) (B_2, B_4, \dots), on the semiconductor device Q2 half cycle.

This advantage of the invention is quite important in light of the large number of batteries in some applications. When

charging twenty seven (27) batteries, for example, conventional battery equalization circuits use one secondary winding and one rectifier bridge with four diodes for each battery. Thus, conventional equalization circuits require 27 secondary windings and 108 output diodes. In contrast, the battery equalization circuit 20 of the invention needs only 14 secondary windings and 27 output diodes. Thus, the battery equalization circuit 20 of the invention decreases the number of secondary windings N_{21}, \dots, N_{2N} by approximately 50% and the number of output diodes D_1, \dots, D_n by approximately 75% as compared to conventional equalization circuits using one secondary winding and one rectifier bridge for each battery.

The battery equalization circuit 20 shown in FIG. 2 is a current source, a half-bridge converter with an inductance, L_o , in series with the primary winding, N_1 , of a transformer, T1, to provide a high output impedance. The average current, I_o , is regulated by increasing the switching frequency, f_s , if the average current, I_o , attempts to increase. The topology bears some resemblance to a series loaded resonant (SLR) converter operated above the resonant frequency, f_o . However, capacitors C_o are so large that their voltage, $V_B/2$, is almost constant and the current waveform is a ramp shape. As a result, the electronic battery equalization circuit 20 of the invention includes a ramp converter power circuit minimizing the voltages across inductor L_o and capacitors C_o . This arrangement also insures an adequate energy of $1/2 L_o I_p^2$ to provide zero voltage switching (ZVS) for semiconductor devices Q1 and Q2.

Electronic battery equalization circuit 20 uses frequency modulation to regulate the average primary current, I_o , and thus the sum of the rectified average secondary currents. As described in more detail below, soft switching or zero voltage switching (ZVS) is employed so that all of the semiconductor devices, Q1, Q2, D_1, \dots, D_n , have zero voltage switching (ZVS) and/or zero current switching (ZCS) at both turn-on and turn-off. Because of these low switching losses, fairly high frequencies can be used by battery equalization circuit 20 of the invention, and the size of the heat sinks and reactive components required by using the invention are minimized.

To avoid the excessively high L_o and C_o voltages that would otherwise result if f_s approaches f_o , the switching frequency, f_s , is purposely selected so that,

$$f_s \gg f_o = \frac{1}{2\pi \sqrt{2 L_o C_o}} \quad (1)$$

where,

f_s =switching frequency,

f_o =resonant frequency,

L_o =inductance of inductor, L_o , and

C_o =capacitance of capacitor, C_o .

Referring now to FIGS. 3 and 4, the shape of the waveform of primary current, i_o , and a more detailed description of the zero voltage switching (ZVS) will now be described. As shown in FIG. 3, the shape of the waveform for primary current, i_o , is a ramp shape. FIG. 4 illustrates an ideal circuit 40 of primary circuit 21 of FIG. 2. In FIG. 4, semiconductor device Q1 of primary circuit 21 is represented by an ideal switch S1 in parallel with its parasitic diode, D1', and output capacitance, C1. Likewise, semiconductor device Q2 of primary circuit 21 is represented by an ideal switch S2 in parallel with its parasitic diode, D2', and output capacitance, C2. Each capacitor C_o of primary circuit 21 is represented by a constant voltage source, $V_B/2$, and the voltage across transformer T1 of primary circuit 21 is represented by a constant voltage source, $|V_o|$, that always opposes current i_o .

On a typical half-cycle, semiconductor device Q2 turns on at $t=0$ and turns off at a predetermined time interval, t_1 . When semiconductor device Q2 turns off, current is diverted through the parasitic diode, D1', in parallel with semiconductor device Q1, and the current decreases until it reaches zero (0) at time t_1+t_2 . Then, semiconductor device Q1 turns on at t_1+t_2 starting the next half-cycle and turns off at time $t_1+t_2+t_3$. When semiconductor device Q1 turns off, current is diverted through parasitic diode D2' in parallel with semiconductor device Q2, and the current reaches zero (0) at a predetermined time, T, equal to $t_1+t_2+t_3+t_4$. Secondary winding circuits N_{21}, \dots, N_{2N} are configured such that an odd numbered battery, (B_1, B_3, \dots), with the lowest voltages will "hog" the current on the semiconductor device Q1 half-cycle, and the even numbered batteries, (B_2, B_4, \dots), will do likewise on the semiconductor device Q2 half-cycle.

Since the switching frequency, f_s , is purposely selected so that $f_s \gg f_o$, it is reasonable to assume that the voltage across capacitors C_o of primary circuit 21 is almost constant. Thus, from the current waveform of FIG. 3 we have,

$$I_p = \left(\frac{0.5 V_B - |V_o|}{L_o} \right) t_1 \quad (2)$$

$$I_p = \left(\frac{0.5 V_B + |V_o|}{L_o} \right) t_2 \quad (3)$$

where,

I_p =primary current,

V_B =source voltage,

V_o =voltage across the primary of T1,

t_1 =first time interval, and

t_2 =second time interval.

Therefore,

$$\frac{T_{SN}}{2} = t_1 + t_2 \equiv L_o I_p \left(\frac{V_B}{.25 V_B^2 - V_o^2} \right) \quad (4)$$

where,

T_{SN} =total time period during a normal circuit. Since the rectified average $i_o = I_o = I_p/2$, then

$$T_{SN} = \frac{4 L_o I_o V_B}{.25 V_B^2 - V_o^2} = \frac{1}{f_s} \quad (5)$$

where,

f_s =switching frequency.

In the extreme case where one output winding is shorted and $V_o=0$ in Equation(5), then

$$T_{SC} = \frac{16 L_o I_o}{V_B} = \frac{1}{f_{sc}} \quad (6)$$

where,

T_{SC} =total time period during a short circuit,

f_{sc} =frequency during the short circuit.

Therefore, from Equations (5) and (6),

$$\frac{(0.25) V_B^2 - V_o^2}{4 L_o I_o V_B} < f_s < \frac{V_B}{16 L_o I_o} \quad (7)$$

If the voltage drops of diodes D1' and D2' and semiconductor devices Q1 and Q2 are ignored, then

$$|V_o| = n V_{B1} \quad (8)$$

$$I_E = n I_o \quad (9)$$

$$V_S = N_B V_{B1} \quad (10)$$

where,

n =turns ratio,

N_B =number of batteries,

V_B = individual low battery voltage, and
 I_E = sum of the average battery equalization currents.
 Therefore, from Equations (7) through (10),

$$\frac{n(25N_B^2 - n^2)V_{BMIN}}{4L_oI_E N_B} < f_s < \frac{nN_B V_{BMAX}}{16L_oI_E} \quad (11)$$

Equation (11) indicates that the turns ratio, n , of transformer T1 can be selected to limit the necessary range for the switching frequency, f_s .

FIG. 5 shows the idealized waveforms for the equalization circuit 40 of FIG. 4. The drive signal, V_{GS2} , turns on semiconductor device Q2 at $t=0$, which is modeled by closing ideal switch S2. However, since i_o is still flowing in the negative direction through parasitic diode D2', i_{SD2} remains negative until i_o reverses at t_a , i_{SD2} and i_o are still identical at this point and increase until $V_{GS2}=0$ at t_b , which means that ideal switch S2 is open. Now that both switches S1 and S2 are open, current is diverted through capacitors C1 and C2 until $V_{DS2}=V_B$ and $V_{DS1}=0$ at t_c . At this time, i_o diverts through parasitic diode D1' and still flows when V_{GS1} turns on switch S1 at t_d . Even though switch S1 was closed at t_a , i_{SD1} cannot begin to flow in the positive direction until i_o reaches zero (0) at t_e . In this manner, the invention provides a zero voltage switching (ZVS) action because the voltage across switches S1 and S2 is always zero when they are opened or closed.

This ZVS action depends on the following conditions:

- (1) The stored energy equal to $\frac{1}{2}L_oI_p^2$ must be adequate to charge both capacitors C1 and C2 after each switch S1 and S2 turn off;
- (2) The gaps between V_{GS1} and V_{GS2} must be long enough to allow both capacitors C1 and C2 to charge; and
- (3) The positive oncoming current, i_{SD} , must start immediately after current, i_o , reaches zero to prevent partial discharge of capacitors C1 and C2 before the start of the next half cycle.

In the invention, the average primary current, I_o is substantially constant, which is equivalent to regulating the sum of the secondary currents. The voltage across the primary winding, N_1 , of transformer T1, V_o , is limited by the reflected individual battery voltage. It is recommended that these required conditions can be achieved by using a variable frequency, f_s , to control the average primary current, I_o , such that:

$$\text{variable } f_s = \frac{1}{2t_d} \gg f_0 \quad (12)$$

and,

$$t_g \equiv t_e - t_b \quad (13)$$

where,

t_g is a fixed gap.

FIG. 6 shows a block diagram of a negative feedback control circuit 60 coupled to current transformer, C_T . The control circuit 60 includes an error amplifier 61, a voltage controlled oscillator (VCO) 62 and a driver 63. Error amplifier 61 compares the primary current, I_o , with a reference current, I_{OREF} , and sends a difference signal to voltage controlled oscillator 62. Driver 63 drives semiconductor devices Q1 and Q2 based on the signal from voltage controlled oscillator 62. In this manner, if the primary current I_o attempts to increase, the negative feedback control circuit 60 detects the difference between I_o and I_{OREF} . This causes f_s to increase, t_b to decrease, and I_o to decrease so that it approximately equals I_{OREF} . Thus, a variable switching frequency, f_s , is used in conjunction with the fixed gap, t_g ,

in the drive waveforms to regulate the average value of $i_o=I_o$. This insures ZVS will result over a wide range of battery voltages. An alternative method would be to use a fixed variable switching frequency, f_s , with pulse width modulation (PWM), but this entails a variable gap, and if the gap is too wide, it would be difficult to guarantee ZVS.

At high values of the switching frequency, f_s , most of the losses in DC—DC converters are usually the switching losses, $P_{S1}=i_{SD1} \times V_{DS1}$ and $P_{S2}=i_{SD2} \times V_{DS2}$, that occur when semiconductor devices Q1 and Q2 are turning on or off. However, in the invention, $V_{DS1}=0$ whenever $i_{SD1} \neq 0$ and $V_{DS2}=0$ whenever $i_{SD2} \neq 0$. Therefore, $P_{S1}=0$ and $P_{S2}=0$ as a result of zero voltage switching (ZVS). Because the switching losses are very low, the battery equalization circuit 20 of the invention can operate at very high values of f_s , for example, 300 kHz, without overheating semiconductor devices Q1 and Q2. This allows the use of very small components for C_o , L_o , T_1 and the heat sinks for semiconductor devices Q1 and Q2. As a result, the size and cost of the electronic battery equalization circuit 20 is reduced.

Typically, the parasitic capacitances of capacitors C1 and C2 are large enough to provide a good approximation to ZVS when semiconductor devices Q1 and Q2 turn off. However, if this is not the case, capacitors C1 and C2 can be supplemented with discrete parallel capacitors (not shown).

During normal operation, the regulation of primary current I_o also regulates the sum of the secondary currents. In the event one or more outputs are shorted, circulating output currents may develop that are much higher than the normal regulated sum ($I_o N_1/N_2$). However, this condition can be avoided with the additional short circuit protection system 70 shown in FIG. 7. The short circuit protection system 70 uses an extra winding, N3, on transformer T1 to monitor the rectified average transformer voltage, V_1 . During a short circuit across any output, V_1 will drop below a reference voltage, V_{1ref} which turns on a comparator 71. The comparator 71 turns on a low frequency, low duty cycle oscillator 72 whose output is combined with the original FET drive signal. This forces the FET's, Q1 and Q2, to remain off during the off-time of this oscillator 72. The total duty cycle of each FET, Q1 and Q2, is now much lower, and the output current is reduced to a safe value while the short circuit is present.

A second preferred embodiment of the invention is illustrated in FIG. 8. The electronic battery equalization circuit 80 of the second preferred embodiment is identical to the equalization circuit 20 of the first preferred embodiment, except that each secondary winding circuit, N_{21}, \dots, N_{2N} , is connected to a single battery.

As in the first embodiment, electronic battery equalization circuit 80 of the second embodiment includes a transformer, T1, a primary circuit 81 and at least one secondary circuit 82. The primary circuit 81 includes a half-bridge circuit including a primary winding, N_1 , an inductor, L_o , connected in series to the primary winding, N_1 , a current transformer, C_T , connected in series to the inductor, L_o , and a pair of semiconductor devices, Q1 and Q2, preferably field-effect transistors (FET's). The half-bridge circuit also includes a pair of capacitors, C_o , to provide a path for current, i_o , and a capacitor, C_s , to minimize the effect of stray inductance. For simplicity, the discussion of like components in the circuit 80 and the operation thereof for the second preferred embodiment is abbreviated.

Unlike the first embodiment, the secondary circuit 82 of the second embodiment includes a secondary winding, N_2 , and output diodes, D_1, \dots, D_{4N} , connected to batteries, B_1, \dots, B_N , using a full wave rectifier. Thus, each secondary circuit 82 of the second embodiment requires four times as

many output diodes, D_1, \dots, D_{4N} , as in the first embodiment. Capacitors, C_B, \dots, C_{BN} , are coupled across each battery, B_1, \dots, B_N .

In addition, the arrangement between the secondary windings, N_{21}, \dots, N_{2N} , the rectifiers or output diodes, D_1, \dots, D_{4N} , and batteries, B_1, \dots, B_N is such that the current is supplied to the lowest voltage batteries of battery pack 83 on both the half cycles of semiconductor devices Q1 and Q2. In contrast, equalization circuit 20 of the first preferred embodiment supplied current to the lowest voltage batteries of one half of battery pack 23 (odd numbered batteries) during the first half cycle of current source 11 and to the lowest voltage batteries of the other half of battery pack 23 (even numbered batteries) during the second half cycle of current source 11.

To prove the principles of the invention, two tests using the electronic battery equalization circuit 20 of FIG. 2 were constructed to provide equalization for a set of twenty-seven (27) 12N85 Horizon lead acid batteries manufactured by Electrosources, Inc. The electronic battery equalization circuit 20 in the first test had a maximum power output of 30 W (15 W for odd numbered batteries and 15 W for even numbered), and operated at a nominal frequency of 220 kHz. The circuit parameters were as follows:

$10.5 \text{ V} \leq V_{B_i} \leq 15.5 \text{ V}$,
 $181 \text{ kHz} \leq f_s \leq 366 \text{ kHz}$,
 Efficiency=86% @ $V_B=400 \text{ V}$,
 $N_B=27$,
 $I_E=2 \text{ A.d.c.}$,
 $C_o=0.68 \text{ } \mu\text{fd}$,
 $L_o=250 \text{ } \mu\text{H}$,
 $n=7:1$, and
 $C_B=100 \text{ } \mu\text{fd}/25 \text{ V}$.

The second test was identical to the first test except the maximum output power of circuit 20 was increased to 60 W, $I_E=4 \text{ A.d.c}$ and $L_o=125 \text{ } \mu\text{H}$.

FIG. 9 shows the waveforms for i_o , V_{gs2} and V_{ds2} for electronic battery equalization circuit 20 for the 60 W version of the second test. The waveforms shown in FIG. 9 are identical to those for the 30 W version, except i_o is twice as large.

To evaluate this form of equalization, one of the original batteries, B_1, \dots, B_N , was replaced with a defective battery, B_{18} , that did not match the characteristics of the others. When charging, the voltage of battery B_{18} would tend to rise faster than the other batteries, B_1, \dots, B_N , and on discharge its voltage would drop faster. A computer controlled charge and discharge system (not shown) similar to that in FIG. 1 was used to cycle the batteries, B_1, \dots, B_N , in the following manner:

Charge:

Max. charge current= $I_C=18 \text{ A.d.c.}$
 Max allowable battery voltage=15.5 V.d.c.
 I_C is halved whenever the high battery voltage reaches 15.5 V.
 Charge time=4 hours

Discharge:

Discharge current=85 A.d.c.
 Min. allowable battery voltage=11.5 V.d.c.
 Discharge is terminated whenever the lowest battery voltage reaches 11.5 V.

FIG. 10 shows a charging profile for battery pack 23 with no defective batteries. The charge for this case was about 38 A.H. (amp-hours). FIG. 11 shows the effect of defective

battery, B_{18} , on the charging profile of FIG. 10. As seen in FIG. 11, the charge decreased to about 26 A.H. from 38 A.H. with no defective batteries. FIG. 12 shows a profile charging using the 30 W ramp equalization circuit 20. As seen in FIG. 12, the charge went back up to almost 34 A.H. This represents an improvement of more than 30% for a 4-hour charge.

FIG. 13 shows a plot of the input charge versus number of cycles with and without the 30 W equalization circuit 20 while defective battery, B_{18} , was present. Note that the plot of FIG. 13 shows a pronounced drop when batteries, B_1, \dots, B_N , were left idle for two days after the second cycle. This indicates fairly serious charge leakage even when batteries, B_1, \dots, B_N , were left in a charged state, implying that a small trickle charge would have been beneficial during this period. In spite of the drop in charge due to leakage, equalization circuit 20 was able to balance the battery pack 23 after two cycles. In some cases, unequalized batteries in battery pack 23 actually may behave much worse than the one shown here, and their charge may continue to drop as the maximum and minimum battery voltages drift further apart on each cycle.

The equalization currents in the batteries, B_1, \dots, B_N , were also measured for both the 30 W and 60 W versions of equalization circuit 20, 80 in order to determine the correlation between each equalization current and each battery voltage in batteries, B_1, \dots, B_N . Batteries, B_1, \dots, B_N , in battery pack 23, 83 were all equalized within the tolerance of the measurements $\pm 0.06 \text{ V}$, except for one defective battery, B_x , whose voltage can be -0.2 V below the average voltage of batteries, B_1, \dots, B_N , in battery pack 23, 83. This low voltage battery B_x would typically draw an equalization current of approximately four times greater than the average current for the other batteries, B_1, \dots, B_N , in battery pack 23, 83. Tests with a battery this defective actually represent a rather extreme case, but the close balance for the other batteries and the higher current for the defective battery B_x indicated that the battery equalization circuit 20, 80 of the invention was still very effective.

In summary, by supplying equalizing current to each half of the battery pack on alternate half cycles, electronic battery equalization circuit with ramp converter of the invention can provide the advantages of soft switching along with a relatively simple transformer. These low losses allow reasonably high switching frequencies, which in turn result in a small physical size. Experimental results confirm that this form of equalization is very effective, and it can be implemented in an economical manner.

While this invention has been described in conjunction with specific embodiments, it is evident that many alternatives, modifications and variations will be apparent to those skilled in the art. Accordingly, the preferred embodiments of the invention as set forth herein are intended to be illustrative, rather than limiting. Various changes may be made without departing from the spirit and scope of the invention as defined in the following claims.

What is claimed is:

1. An electronic battery equalization circuit for equalizing voltages of a plurality of batteries in a battery pack, comprising:

- a current source for supplying a charging current during a first half cycle and a second half cycle;
- a transformer connected to said current source;
- a primary circuit connected to said transformer, said primary circuit comprising a primary winding, an inductor connected in series to the primary winding, a current transformer connected in series to the inductor and a pair of semiconductor devices; and

at least one secondary circuit connected to said transformer comprising a secondary winding being coupled to a different pair of batteries of the plurality of batteries, a pair of diodes connected in series, each diode being connected to a different battery of the plurality of batteries, and a capacitor being connected across the different battery of the plurality of batteries, wherein the charging current from said current source is supplied to at least one battery in a first half of the battery pack during the first half cycle, and wherein a charging current from said current source is supplied to at least one battery in a second half of the battery pack during the second half cycle.

2. The electronic battery equalization circuit according to claim 1, wherein each diode of the pair of diodes conducts the charging current to the at least one battery in the first half of the battery pack during the first half cycle when a voltage of the at least one battery is substantially equal to a lowest voltage among batteries in the first half of the battery pack.

3. The electronic battery equalization circuit according to claim 1, wherein each diode of the pair of diodes conducts the charging current to the at least one battery in the second half of the battery pack during the second half cycle when a voltage of the at least one battery is substantially equal to a lowest voltage among batteries in the second half of the battery pack.

4. The electronic battery equalization circuit according to claim 1, wherein the charging current is supplied to the plurality of batteries using zero voltage switching.

5. The electronic battery equalization circuit according to claim 1, wherein the charging current has a switching frequency, f_s , expressed as:

$$f_s \gg f_o = \frac{1}{2\pi \sqrt{2 L_o C_o}}$$

where,

f_o is a resonant frequency of said battery equalization circuit;

L_o is an inductance of the inductor; and

C_o is a capacitance of the capacitor.

6. The electronic battery equalization circuit according to claim 1, wherein said pair of semiconductor devices comprise field-effect transistors.

7. The electronic battery equalization circuit according to claim 1, wherein the primary circuit further comprises a negative feedback control circuit coupled to the current transformer.

8. The electronic battery equalization circuit according to claim 7, wherein said feedback control circuit comprises an error amplifier coupled to the current transformer, a voltage controlled oscillator coupled to the error amplifier and a driver coupled to the voltage controlled oscillator for outputting a drive signal to the pair of semiconductor devices.

9. The electronic battery equalization circuit according to claim 8, wherein the error amplifier compares the charging current to a reference charging current and outputs a signal to the voltage controlled oscillator representing a difference between the charging current and the reference charging current.

10. The electronic battery equalization circuit according to claim 7 further comprising a short circuit protection system coupled to said feedback control circuit.

11. The electronic battery equalization circuit according to claim 10, wherein said short circuit protection system comprises a comparator connected to said transformer for comparing a voltage from said transformer to a reference

voltage and an oscillator connected to said comparator for supplying an output signal being combined with the drive signal from the voltage controlled oscillator.

12. An electronic battery equalization circuit, comprising: a supply source for supplying charging current; a plurality of batteries connected in series; and a transformer coupled to said supply source, said transformer having a primary circuit and at least one secondary circuit being connected to a different pair of batteries of said plurality of batteries.

13. The electronic battery equalization circuit according to claim 12, wherein said primary circuit comprises a primary winding, an inductor connected in series to the primary winding, a current transformer connected in series to the inductor and a pair of semiconductor devices.

14. The electronic battery equalization circuit according to claim 13, wherein the at least one secondary circuit comprises a secondary winding, a pair of diodes connected in series, each diode being connected to a different battery of said plurality of batteries, and a plurality of capacitors, each capacitor being connected across a different battery of said plurality of batteries.

15. The electronic battery equalization circuit according to claim 14, wherein the charging current is supplied to at least one battery in one half of said plurality of batteries during a first half cycle of said supply source, and wherein the charging current is supplied to at least one battery in the other half of said plurality of batteries during a second half cycle of said supply source.

16. The electronic battery equalization circuit according to claim 12 further comprising a feedback control circuit coupled to the primary circuit for controlling the charging current from said supply source.

17. The electronic battery equalization circuit according to claim 12, wherein the charging current is supplied to said plurality of batteries using zero voltage switching.

18. An electronic battery equalization circuit for equalizing voltages of a plurality of batteries in a battery pack, comprising:

a current source for supplying a charging current during a first half cycle and a second half cycle;

a transformer connected to said current source;

a primary circuit connected to said transformer, said primary circuit comprising a primary winding, an inductor connected in series to the primary winding, a current transformer connected in series to the inductor and a pair of semiconductor devices; and

at least one secondary circuit connected to said transformer comprising a secondary winding being coupled to a battery of the plurality of batteries using a full wave rectifier and a capacitor being connected across the battery of the plurality of batteries,

wherein the charging current is supplied to lowest voltage batteries in the battery pack during the first half cycle of said current source, and

wherein the charging current is supplied to lowest voltage batteries in the battery pack during the second half cycle of said current source.

19. The electronic battery equalization circuit according to claim 18, wherein the charging current is supplied to the plurality of batteries using zero voltage switching.

20. The electronic battery equalization circuit according to claim 18 wherein the primary circuit further comprises a negative feedback control circuit coupled to the current transformer.

21. The electronic battery equalization circuit according to claim 20, wherein said feedback control circuit comprises

an error amplifier coupled to the current transformer, a voltage controlled oscillator coupled to the error amplifier and a driver coupled to the voltage controlled oscillator for outputting a drive signal to the pair of semiconductor devices.

22. The electronic battery equalization circuit according to claim 21, wherein the error amplifier compares the charging current to a reference charging current and outputs a signal to the voltage controlled oscillator representing a difference between the charging current and the reference charging current.

23. The electronic battery equalization circuit according to claim 20 further comprising a short circuit protection system coupled to said negative feedback control circuit.

24. A method for equalizing voltages of a plurality of batteries in a battery pack using an electronic battery equalization circuit, the battery equalization circuit comprising a current source for supplying charging current during a first half cycle and a second half cycle, a transformer connected to the current source, a primary circuit connected to the transformer, and at least one secondary circuit connected to at least two different batteries of the plurality of batteries, the method comprising the steps of:

supplying the charging current to a lowest voltage battery in one half of the battery pack during the first half cycle; and

supplying the charging current to a lowest voltage battery in the other half of the battery pack during the second half cycle.

25. A method for charging a plurality of batteries according to claim 24, further comprising the steps of monitoring the voltage of the plurality of batteries and controlling the charging current such that each of the plurality of batteries is charged to a predetermined threshold level.

26. A method for charging a plurality of batteries according to claim 24, wherein the primary circuit comprises a primary winding, an inductor coupled to the primary winding, a current transformer coupled to the inductor, and a pair of semiconductor devices.

27. A method for charging a plurality of batteries according to claim 24, further comprising the step of comparing the charging current to a reference charging current using a feedback control circuit.

28. A method for charging a plurality of batteries according to claim 27, wherein the feedback control circuit comprises an error amplifier coupled to the current transformer, a voltage controlled oscillator coupled to the error amplifier and a driver coupled to the voltage controlled oscillator for outputting a drive signal to the pair of semiconductor devices.

* * * * *